

NOVIKSTONE DS DRY STACK INSTALLATION GUIDE



BARRON
DESIGNS

GENERAL INFORMATION

CAUTION: REMEMBER THAT POLYMER UNDERGOES EXPANSION/CONTRACTION DUE TO VARIATIONS IN TEMPERATURE. THE FOLLOWING INSTRUCTIONS WILL ALLOW FOR THE EXPANSION / CONTRACTION OF THE MATERIAL.

Note: When installing near a heat source such as a fireplace, etc., the installer is responsible to ensure that the installation is at a safe distance such that the panels will not exceed 176°F(80°C).

1-Always begin the installation at the lowest part of the structure, from left to right.

2-Always nail through the installation holes. These holes include a polymer film, which permits for precise centering of the nail, allowing the expansion and contraction of the material. Each complete panel must be nailed through the center hole, at both extremities and have a minimum of 5 nails in the nailing channel at maximal intervals of 16"(40,64cm) or less and one nail in each lateral hole (Figure 1). If panels are installed on a furring wall, furring strips should be at 8"(20,32cm) center to center and a furring strip is required behind each nail. Always use non-corrosive nails or screws with a head of 0.4"(1cm) in diameter and a body of 0.150"(0,38cm) in diameter and penetrate a minimum of 1 1/4"(3,18cm) into a solid surface.

3-Never hammer the nails in completely; leave a gap of 1/16"(0,16cm). The stoppers located around the holes help to stop the hammer from driving the nails in too far, and provides the required gap. (Figure 2)

4-Make sure that all pieces are properly joined together (Figure 3).

5-When using finition trim (i.e. Novik Trim, J-trim, etc.) leave a gap of 1/4"(0,64cm) between the trim and the siding (Figure 4). The required opening for finition trim is 1 1/8"(2,86cm).

Note: To cut the material, it is recommended to use a circular saw with a finishing blade.

-Keep the R-E-L number of your products (ex: REL-123456) for future reference.

Figure 1

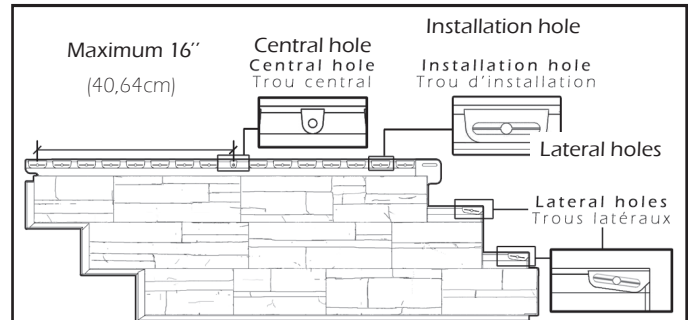

Figure 2

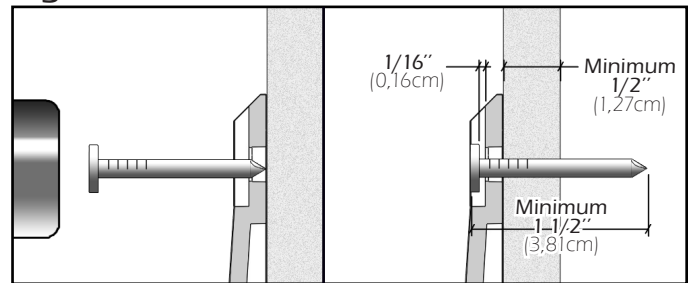

Figure 3

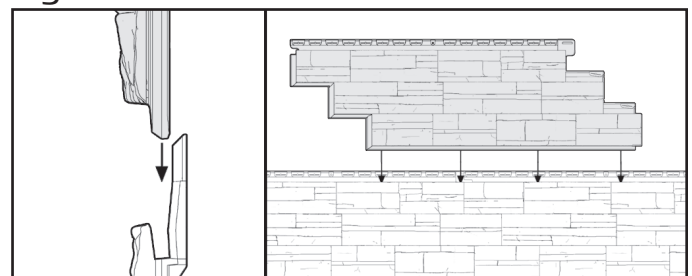
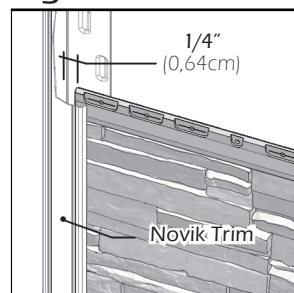

Figure 4



Some elements of the image above were partly removed to facilitate understanding.

NOVIK DRY STACK INSTALLATION GUIDE



BARRON
DESIGNS

INSTALLATION STEPS

1-First install the decorative corners if needed (see corners installation section). Then install the starter strips at the lowest point of the structure. Make sure that the horizontal starting line is perfectly leveled and square with the wall. Leave a 1/2" (1,27cm) gap at each end of the wall when using Novik Trim (1). If the lowest installation point is against the floor you must leave a gap of 1 13/16" (4,61cm) between the starter and the floor (2). If the lowest installation point is not against the floor, starter strips should be flush with this lowest point. Nail the starter strips through the nailing holes at maximal intervals of 8" (20,32cm) or less. Do not forget to nail through the center hole (3). Install the next starter strip by sliding it leftward to the stopper in the previous strip and nail it as mentioned above (4)(Figure A). **Note:** For an installation with Novik Trim at the bottom of the wall, refer to Tips & Advices section at the end of the guide.

Figure A

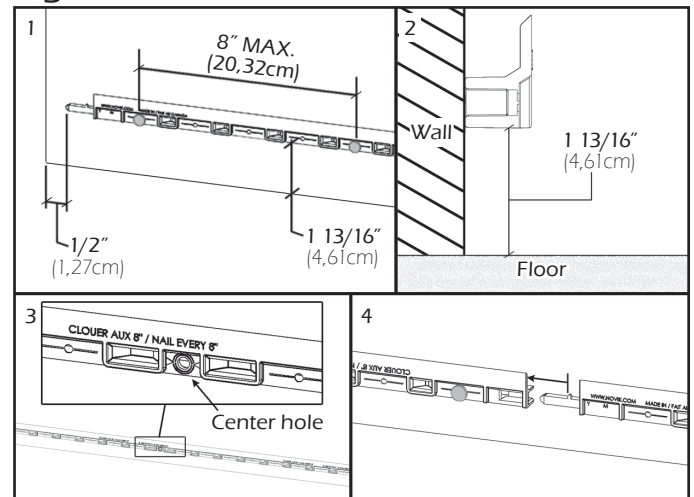

2-Cut the left side of a panel in a clean straight line as this cut will be visible. Insert the panel onto the starter strip using the hooks on the back of the panel and slide it up to the decorative corners. It is not necessary to leave a gap between the corners and the panel (Figure B). When using Novik Trim, cut the left side of a panel in a straight line, insert the cut side of the panel into the Novik Trim. Leave a space of 1/4" (0,64cm) between the inside wall of the trim and the panel (Figure C).

Note: Measure the wall length to determine where to cut your first panel in order to avoid having a very small piece at the right end of the wall. Be sure to align adjacent walls. For a better look, it is recommended to cut panels which are pressed against the corners with a 3° angle.

Figure B

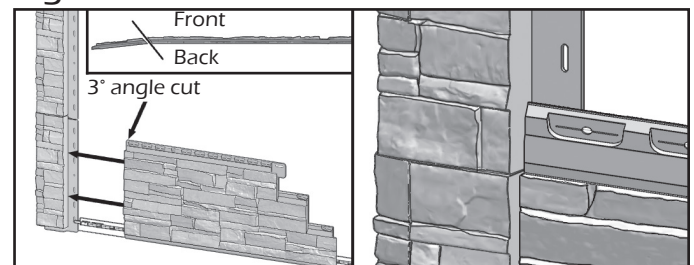
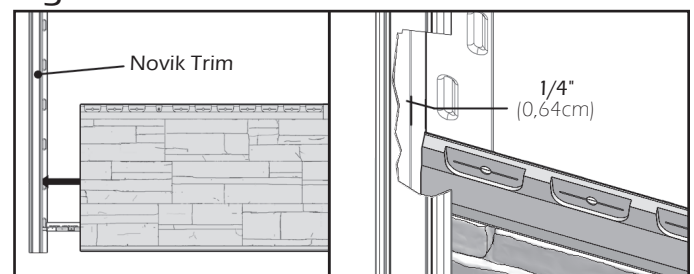

Figure C



Some elements of the image above were partly removed to facilitate understanding.

NOVIK DRY STACK INSTALLATION GUIDE



BARRON
DESIGNS

INSTALLATION STEPS (CONTINUATION)

3-For each panel, before beginning nailing, make sure to position the left side of panel in order to have an optimal appearance between panels. Hold in place and nail the left end of the nailing channel. Thereafter, while maintaining the panel down to preserve optimal appearance of the lower joint, nail down the center hole. This will ensure even movement of panel in both directions during expansion and contraction. Repeat to nail the right end of the nailing channel and the two lateral holes (Figure D). If the panel is installed on a wall with furrings, a furring strip is required behind each nail. Each full length panel should be secured with a minimum of 5 nails.

Note: If a panel piece does not have the initial center hole, drill a new center hole of 1/8"(0,32cm) diameter at the same height as the other installation holes in the middle of the piece.

4-Install the following panel by hooking onto the starter strip and sliding into the previous panel. Make sure that the tabs on both sides are locked together. It is not necessary to leave a gap between the panels, you can butt them upto each (Figure E). Repeat this step until the end of the wall.

5-Start the second row by cutting the first panel with 16"(40,6cm) increment from the cutting line of the first row. Slide the bottom of the panel into the continuous slot on top of the previously installed row. Proceed with this row and subsequent ones following steps 3, 4 and 5 taking care with each new row to alternate the position of the cut on the first panel (Figure F).

Figure D

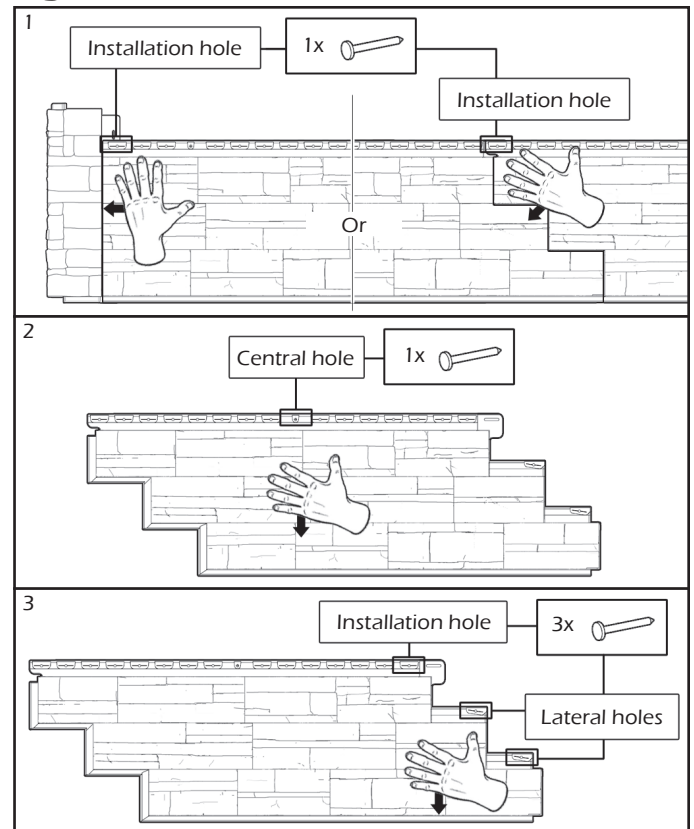

Figure E

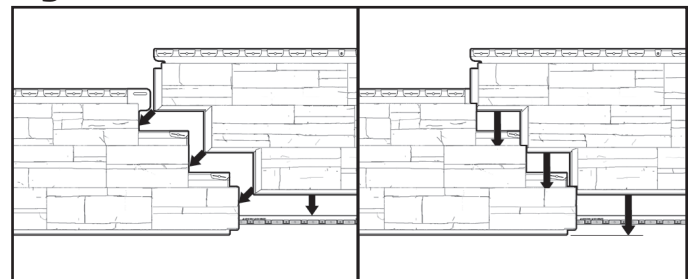
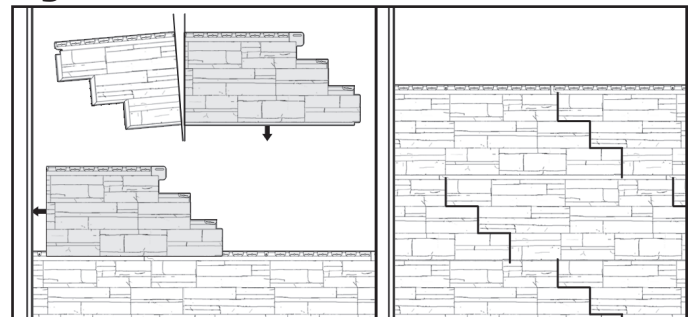

Figure F



NOVIK DRY STACK INSTALLATION GUIDE

INSTALLATION STEPS (CONTINUATION)

6-For the last row or places where you may need to attach siding after removing the installation holes, choose a concealed spot on the panel, and use a knife to create new 1/2" (1,27cm) slots (Figure G); the slot must be wider than the nail but not as wide as the nail head. Although not set in installation holes, this type of slot will allow the expansion/contraction movement.
Note: To straighten the panel, add some shims as required behind these new nailing slots.

Figure G

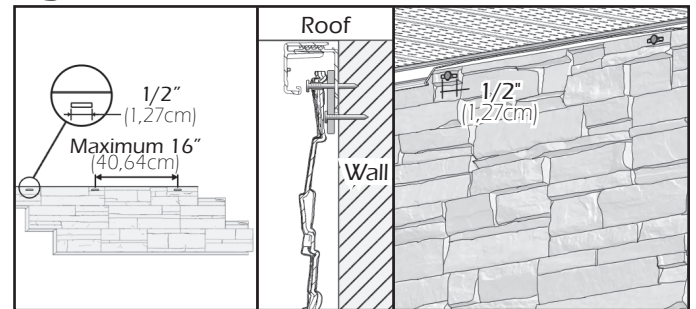

Some elements of the image above were partly removed to facilitate understanding.

DECORATIVE CORNERS INSTALLATION

1-To begin the decorative corners installation, join two decorative corner sections together so as to form an inside or an outside corner as required. One corner assembly has a linear coverage of 15.1" (38,35cm) (Figure H).

2-Install a first corner assembly at the bottom of the wall and nail the central hole and both extremities on each piece. If the corner is installed at the base of a wall butt the bottom of the corner assembly against the floor. If there is no floor, install the corner flush with the lowest installation point. (Figure I).

Figure H

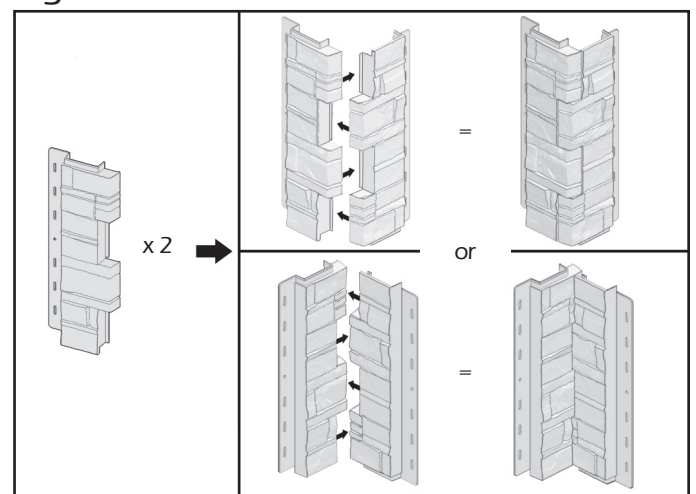
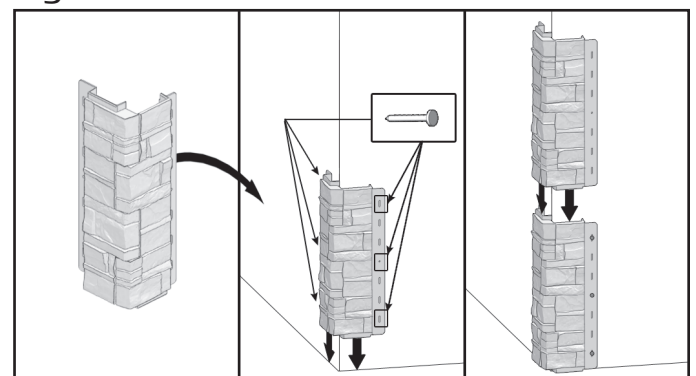

Figure I



NOVIK DRY STACK INSTALLATION GUIDE



BARRON
DESIGNS

CORNERS INSTALLATION (CONTINUATION)

3-Install another corner assembly on the wall by inserting it into the lower one and nailing as mentioned in the previous step (Figure I). Repeat until the top of the wall.

4-For the last corner only, cut the excess, insert it into the lower one and nail it into the wall. If there is no center hole, only nail the two extremities (Figure J).

5-Start siding installation as mentioned in step no:1 of the guide.

Figure J

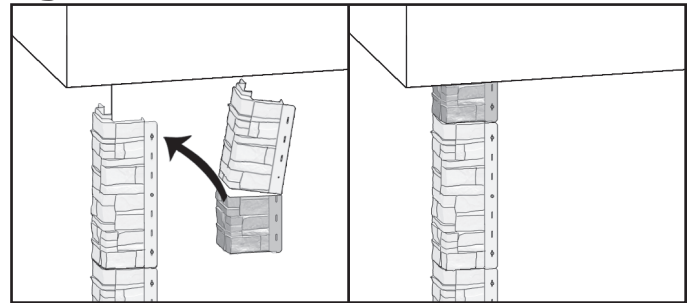

ALTERNATIVE FINISHES AT THE BASE OF WALLS

1-You may install the first rows of panels with Novik Trim at the wall's base in order to have a neater appearance. To do this, install starter strips at 2 1/4"(5,72cm) from wall's base or above the lowest installation point and install Novik Trim Base at 3/16"(0,48cm) from wall's base or above the lowest point (1). Continue the usual installation of the guide from step no:2. Once the first row of wall is completed, install a Novik Trim Top to the desired depth (2) (Figure K).

2-You may install the first rows of panels and corners by cutting the tab at the bottom of the parts in order to have a neater appearance. To do this, only cut the parts required for the installation of the first row of the walls. Make sure to do a straight cut without burrs (Figure L). Then follow the installation steps of the guide from the first step by installing starter strips 1/2"(1,27cm) lower than the specified measure at this step.

Figure K

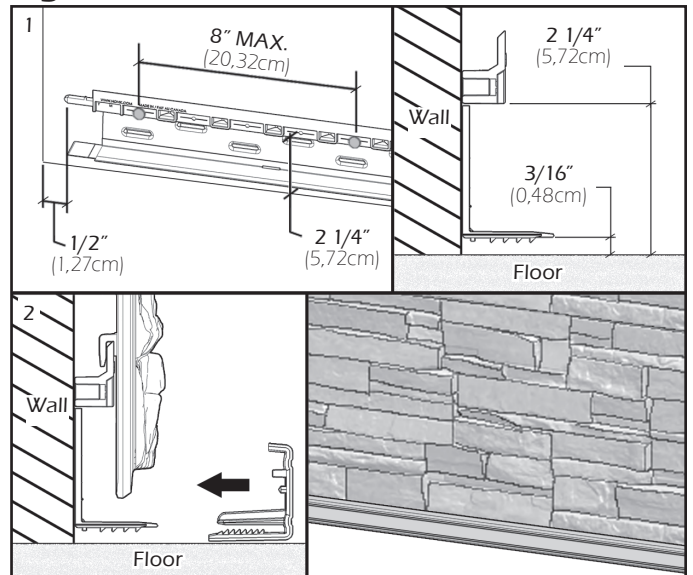

Figure L

